

# F5

## COMBIVERT F5

MADE  
IN  
GERMANY



## Modular Drives



# Frequency Inverter KEB COMBIVERT F5

Reputable manufacturers are using with **KEB COMBIVERT** to produce innovative high quality machine systems. Digital power transmission with highest bandwidth and power density is the result of continuous development and the use of modern electronic modules.



**COMBIVERT F5**



**KEB COMBIVERT F5** are frequency inverters and servo systems in the power range from 0.37 to 900 kW. They provide a modular program for the mechanical engineering, that meet the different requirements in flexibility with the aim of

- optimal use of resources and materials and
- minimum expense in design and easy implementation of application solutions.

**Simple handling** and **multipurpose features** were often contradictory. The **CP** mode **ensures user-friendly handling via a programmable menu**. In the subordinate application level KEB COMBIVERT F5 is the world's first drive generation to have a fully programmable user surface, which is equipped with a plain text operator guidance in 6 languages.

Content			
KEB COMBIVERT F5 <b>Basic</b>	4	KEB COMBIVERT F5 <b>Software function</b>	19
KEB COMBIVERT F5 <b>Compact</b>	6	KEB COMBIVERT F5 <b>APPLICATION</b>	20
KEB COMBIVERT F5 <b>Multi</b>	8	Drive-based <b>control technology</b>	21
KEB COMBIVERT F5 <b>Multi</b> voltage class 690 V	10	KEB COMBIVERT F5 <b>LCD operator</b>	22
KEB COMBIVERT F5 <b>Multi</b> with safety function	11	KEB COMBIVIS <b>PC software</b>	23
KEB COMBIVERT F5 <b>Multi</b> encoder systems	12	<b>Operation</b> and display	24
KEB COMBIVERT F5 <b>Multi</b> encoder cables	13	<b>Field bus connection</b>	25
KEB COMBIVERT F5- <b>H</b> Asynchronous-Sensorless-Closed Loop	14	KEB COMBILINE <b>Filter technology and chokes</b>	26
KEB COMBIVERT F5- <b>E</b> Sensorless-Closed Loop	15	KEB COMBILINE <b>Braking resistors</b>	28
KEB COMBIVERT F5 <b>Assembly kit</b>	16	KEB MOTORS <b>Motor technology</b>	30
KEB COMBIVERT F5 <b>Mechanical dimensions</b>	17	KEB COMBIGEAR <b>Gear technology</b>	31
KEB COMBIVERT F5 <b>Hardware specification</b>	18	KEB Addresses	32

## Open-loop systems

Basic	0.37 ... 15 kW
Compact	0.37 ... 90 kW

compact units with 230 V and 400 V connection in functional and economical orientation and universal features create the ideal platform for the design of high-quality machines and systems.



## Closed-loop systems

Multi	0.75 ... 900 kW
-------	-----------------

closed-loop drives of voltage classes 230 V, 400 V and 690 V for asynchronous and synchronous servo motors with feedback devices.



## Application

customized equipment solutions tailored to operating conditions and requirements.

## Examples are the software versions

- ASCL, encoder-less field orientation for asynchronous motors
- SCL for closed loop performance without a feedback device
- versions with special adapted hardware and software



## Frequency inverters from simple to sophisticated - in open-loop tasks throughout the engineering sector ...

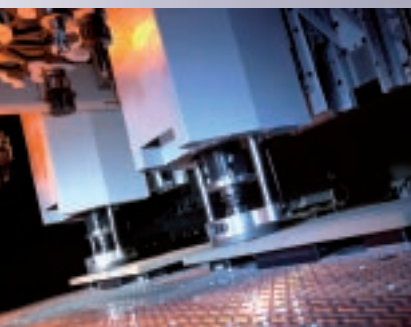

- connection 1-/3-phase 230 V and 3-phase 400 V, choice of AC or DC supply in one unit
- optimized **KEB-SMM** control algorithm (sensorless motor management)
- 17 pluggable control terminals, PNP-logic
- analog input 0 ... 10 V,  $\pm 10$  V, 0 / 4 ... 20 mA (housing D, E)
- programmable analog output 0 ...  $\pm 10$  V
- 5 programmable digital inputs
- 2 programmable relay outputs
- 4 programmable software inputs/outputs
- 8 free-to-program parameter sets including S-curves, ramp stop, power-off-function, DC-braking, PID controller, electronic motor protection, brake control, internal timer, counter input, energy saving function
- output frequencies up to 1600 Hz, output voltage control, adjustable switching frequencies up to 16 kHz
- controlled positioning to end position/counter pulse
- high-dynamic scanning of the control terminals and the serial interface in 2 ms
- $\pm$  DC-link connection, internal braking chopper GTR7, motor-PTC-evaluation,
- integrated filter to EN 55011/C1 (option: B-, D-, E-housing)
- potential-free operator connection with serial interfaces for:



	$P_N$ [kW]	housing	$I_N$ [A]	$I_{max}$ [A]	$f_{sN/max}$ [kHz]	EMC		part no.
<b>1-/3-ph. 230 V</b> (180 ... 260 V)	0.37	A*	2.3	5	4/8	C1	●	05.F5.B3A-090A
	0.75	A*	4	8.6	8	C1	●	07.F5.B3A-0A0A
	1.5	B	7	15.1	16	C1	◆	09.F5.B1B-2B0A
	2.2	B	10	21.6	8/16	C1	◆	10.F5.B1B-2A0A
	4	D**	16.5	35.6	8/16	C1	◆	12.F5.B1D-1A0A
	5.5	E**	24	43	8/16	C1	◆	13.F5.B1E-160A
	7.5	E**	33	59	4/16	C1	◆	14.F5.B1E-150A
<b>3-ph. 400 V</b> (305 ... 500 V)	0.37	A	1.3	2.8	4	C1	●	05.F5.B3A-390A
	0.75	A	2.6	5.6	4	C1	●	07.F5.B3A-390A
	1.5	A	4.1	8.9	4	C1	●	09.F5.B3A-390A
	2.2	B	5.8	12.5	8/16	C1	◆	10.F5.B1B-3A0A
	4	B	9.5	21	4	C1	◆	12.F5.B1B-350A
	5.5	D	12	25.9	4/16	C1	◆	13.F5.B1D-390A
	7.5	D	16.5	35.6	2	C1	◆	14.F5.B1D-380A
	11	E	24	43	4/16	C1	◆	15.F5.B1E-350A
	15	E	33	59	2	C1	◆	16.F5.B1E-340A

● internal  
\* 1-phase 230 V AC

◆ footprint (option)  
\*\* 3-phase 230 V AC

**Generally:**

Product standard EN 61800-2, -5-1  
 Emitted interference EN 61800-3  
 EN 61000-6 -1...4  
 Enclosure IP 20 / VBG 4  
 Storage temperature -25 ... 70 °C  
 Operation temperature -10 ... 45 °C  
 Short-circuit and earth fault monitoring



## More than just an inverter... high technology for open-loop drive systems

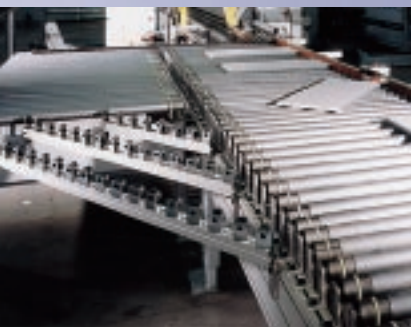

- wide power range for 230 V and 400 V connection
- either AC or DC connection
- optimal characteristics at the motor shaft in different application areas with **KEB-SMM** (sensorless motor management)
- 29 plug-in control terminals, PNP- / NPN logic switchable
- 2 analog inputs 0 ... 10 V,  $\pm 10$  V, 0 / 4 ... 20 mA
- 2 programmable analog outputs 0 ...  $\pm 10$  V
- 8 programmable digital inputs
- programmable outputs: 2 x relay, 2 x transistor
- 4 programmable software inputs/outputs
- 8 free-programmable parameter sets including S-curves, ramp stop, power-off-function, DC-braking, PID controller, electronic motor protection, brake control, internal counter input, output frequencies up to 1600 Hz, output voltage control, switching frequencies up to 16 kHz, output phase monitoring, energy saving function
- scan time of the control terminals in 2 ms-time pattern
- $\pm$  DC-link connection, motor-PTC evaluation, hardware current limit
- internal brake chopper (series up to housing size G, option from housing size H)
- controlled positioning to end position/counter pulse
- optional: execution in accordance with EN 954-1 protection category 3: protection against unintended restart
- potential-free operator connection with serial interfaces for:



3-ph. 230 V (180 ... 260 V)	$P_N$ [kW]	housing	$I_N$ [A]	$I_{max}$ [A]	$f_{sN/max}$ [kHz]	EMC	part no.
	0.37	B*	2.3	5	16	C1 ◆	05.F5.C1B-2B0A
	0.75	B*	4	8.6	16	C1 ◆	07.F5.C1B-2B0A
	1.5	B*	7	15.1	16	C1 ◆	09.F5.C1B-2B0A
	2.2	B*	10	21.6	8/16	C1 ◆	10.F5.C1B-2A0A
	4	D	16.5	35.6	8/16	C1 ◆	12.F5.C1D-1A0A
	5.5	E	24	43	8/16	C1 ◆	13.F5.C1E-160A
	7.5	E	33	59	4/16	C1 ◆	14.F5.C1E-150A
	11	G	48	86	8/16	C1 ◆	15.F5.C1G-190F
	15	H	66	119	16	C1 ◆	16.F5.C0H-1B0F
	18.5	H	84	151	8/16	C1 ◆	17.F5.C0H-190F
	22	R	100	180	8	C1 ●	18.F5.C0R-760A
30	R	115	206	8	C1 ●	19.F5.C0R-760A	
37	R	145	261	8	C1 ▲	20.F5.C0R-760A	
45	R	180	324	8	C1 ▲	21.F5.C0R-760A	

3-ph. 400 V (305 ... 500 V)	$P_N$ [kW]	housing	$I_N$ [A]	$I_{max}$ [A]	$f_{sN/max}$ [kHz]	EMC	part no.
	0.37	B	1.3	2.8	16	C1 ◆	05.F5.C1B-3B0A
	0.75	B	2.6	5.6	16	C1 ◆	07.F5.C1B-3B0A
	1.5	B	4.1	8.9	8/16	C1 ◆	09.F5.C1B-3A0A
	2.2	B	5.8	12.5	8/16	C1 ◆	10.F5.C1B-3A0A
	4	B	9.5	21	4	C1 ◆	12.F5.C1B-350A
	5.5	D	12	25.9	4/16	C1 ◆	13.F5.C1D-390A
	7.5	D	16.5	35.6	2/16	C1 ◆	14.F5.C1D-380A
	11	E	24	48	4/16	C1 ◆	15.F5.C1E-350A
	15	E	33	59	2/16	C1 ◆	16.F5.C1E-340A
	18.5	G	42	75	4/16	C1 ◆	17.F5.C1G-350A
	22	G	50	90	2/8	C1 ◆	18.F5.C1G-340F
30	H	60	108	4/16	C1 ◆	19.F5.C0H-350F	
37	H	75	135	2/8	C1 ◆	20.F5.C0H-340F	
45	R	90	162	4/16	C1 ●	21.F5.C0R-950A	
55	R	115	207	4/16	C1 ●	22.F5.C0R-950A	
75★	R	150	270	2/12	C1 ●	23.F5.C0R-940A	
90★	R	180	324	2/8	C1 ▲	24.F5.C0R-940A	

**Generally:**

Product standard EN 61800-2, -5-1  
 Emitted interference EN 61800-3  
 EN 61000-6-1...4  
 Enclosure IP 20 / VBG 4  
 Storage temperature -25 ... 70 °C  
 Operation temperature -10 ... 45 °C  
 from 90 kW -10 ... 40 °C  
 Short-circuit and earth fault monitoring

- internal (option)
- \* 1-/3-phase 230 V AC
- ◆ footprint (option)
- ▲ book-style (option)
- ★ mains choke generally required (page 26)



## Open-loop and closed-loop drive controller for synchronous and asynchronous motors...



The frequency inverter **KEB COMBIVERT F5 Multi** is equipped with all functions and characteristics of the **KEB COMBIVERT F5 Compact** series and furthermore especially prepared for closed-loop operation.

Very flexible because of plug-in feedback cards

- Resolver
- Incremental encoder, initiator
- Sin/Cos encoder
- Absolute encoder
- Hiperface®, EnDat®
- BISS or Tacho

and usable in the operation modes

**KEB-SMM** (sensorless motor management) **F5-G**

**Field-oriented control F5-M**

**Synchronous motor control F5-S**

Decentralized automation in the drive actuator with standard functions relieves superior control systems and create clear, compact programs.

- speed and torque control
- position control
- synchronous speed control, electronic gear

or customer-specific solutions such as

- cam switch
- register function
- single-axis positioning
- rotary table positioning
- contouring control

Potential-free operator connection with serial interfaces for:





3-ph. 230 V (180 ... 260 V)	$P_N$	housing	$I_N$	$I_{max}$	$f_{sN/max}$	EMC	part no.
	[kW]		[A]	[A]	[kHz]		
	0.37	A	2.3	4.6	8	C1 ◆	05.F5.A1A-2E2F
	0.75	A	4	8	16	C1 ◆	07.F5.A1A-2E2F
		D*	4	8.6			07.F5.A1D-2B_A
	1.5	D*	7	15.1	16	C1 ◆	09.F5.A1D-2B_A
	2.2	D*	10	21.6	16	C1 ◆	10.F5.A1D-2B_A
	4	D*	16.5	35.6	8/16	C1 ◆	12.F5.A1D-1A_A
	5.5	E	24	43	8/16	C1 ◆	13.F5.A1E-16_A
	7.5	E	33	59	4/16	C1 ◆	14.F5.A1E-15_A
	11	G	48	86	8/16	C1 ◆	15.F5.A1G-19_F
	15	H	66	119	16	C1 ◆	16.F5.A1H-1B_F
	18.5	H	84	151	8/16	C1 ◆	17.F5.A1H-19_F
	22	R	100	180	8/16	C1 ●	18.F5.A1R-76_A
	30	R	115	206	8/16	C1 ●	19.F5.A1R-76_A
37	R	145	261	8/16	C1 ▲	20.F5.A1R-76_A	
45	R	180	324	8/16	C1 ▲	21.F5.A1R-76_A	

- internal (option)
- \* 1,5 ... 2,2 kW = 1-/3-phase 230 V
- ◆ footprint (option)
- ▲ book-style (option)
- ★ mains choke generally required (page 26)
- \*\* module units 2 x P / 3 x P generally with output choke (page 26)

### Generally:

Product standard EN 61800-2, -5-1  
 Emitted interference EN 61800-3  
 EN 61000-6-1...4  
 Enclosure IP 20 / VBG 4  
 Storage temperature -25 ... 70 °C  
 Operation temperature -10 ... 45 °C  
 from 90 kW -10 ... 40 °C  
 Short-circuit and earth fault monitoring

### Control terminal housing A

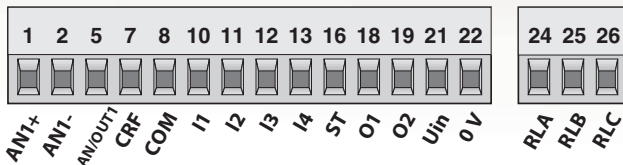

### Control terminal housing D...W

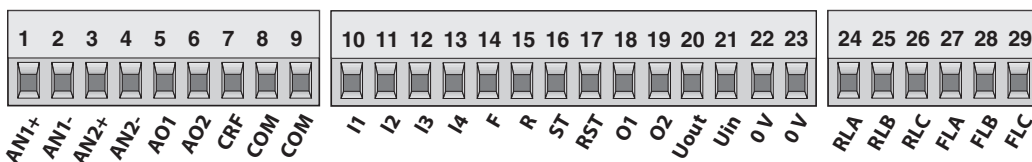

3-ph. 400 V (305 ... 500 V)	$P_N$	housing	$I_N$	$I_{max}$	$f_{sN/max}$	EMC	part no.
	[kW]		[A]	[A]	[kHz]		
	0.75	A	2.6	5.2	8/16	C1 ◆	07.F5.A1A-3E2F
		D	2.6	5.6			07.F5.A1D-3B_A
	1.5	A	4.1	8.2	8/16	C1 ◆	09.F5.A1A-3D2F
		D	4.1	7.4			09.F5.A1D-3A_A
	2.2	D	5.8	10.4	4/16	C1 ◆	10.F5.A1D-3A_A
	4	D	9.5	17	8/16	C1 ◆	12.F5.A1D-3A_A
	5.5	D	12	21.6	4/16	C1 ◆	13.F5.A1D-39_A
	7.5	D	16.5	29.7	2/16	C1 ◆	14.F5.A1D-38_A
	11	E	24	36	4/16	C1 ◆	15.F5.A1E-35_A
	15	E	33	49.5	2/16	C1 ◆	16.F5.A1E-34_A
	18.5	G	42	63	4/16	C1 ◆	17.F5.A1G-35_A
	22	G	50	75	2/16	C1 ◆	18.F5.A1G-34_F
	30	H	60	90	4/16	C1 ◆	19.F5.A1H-35_F
37	H	75	112	2/4	C1 ◆	20.F5.A1H-34_F	
45	R	90	135	4/16	C1 ●	21.F5.A1R-95_A	
55	R	115	172	4/16	C1 ●	22.F5.A1R-95_A	
75★	R	150	225	2/12	C1 ●	23.F5.A1R-94_A	
90★	R	180	270	2/8	C1 ▲	24.F5.A1R-94_A	
110★	U	210	263	4/8	C2/C1 ▲	25.F5.A1U-91_A	
132★	U	250	313	4/8	C2/C1 ▲	26.F5.A1U-91_A	
160★	U	300	375	2/8	C2/C1 ▲	27.F5.A1U-90_A	
200★	P	370	463	2/4	C2 ▲	28.F5.A1P-90_A	
250★	P	460	575	2/4	C2 ▲	29.F5.A1P-90_D	
315★	W	570	713	2/4	C2 ▲	30.F5.A1W-A0_A	
355★	W	630	787	2/4	C2 ▲	31.F5.A1W-A0_D	
400★	W	710	887	2/4	C2 ▲	32.F5.A1W-A0_D	
450★	2 x P**	800	1000	2/4	C2 ▲	33.F5.A1P-90_D	
500★	2 x P**	890	1112	2/4	C2 ▲	34.F5.A1P-90_D	
630★	3 x P**	1150	1435	2/4	C2 ▲	36.F5.A1P-90_D	
710★	3 x P**	1330	1660	2	C2 ▲	37.F5.A1P-90_D	
800★	3 x P**	1450	1810	2	C2 ▲	38.F5.A1P-90_H	

Selection and dimensioning of the synchronous and asynchronous control motors occurs according to rated-, standstill- and peak current.

# KEB COMBIVERT F5 Multi voltage class 690 V

## Proven characteristics for the use in the upper power range

3-ph. 660/690 V (600 ... 760 V)	$P_N$ [kW]	housing	$I_N$ [A]	$I_{max}$ [A]	$f_{sN/max}$ [kHz]	inverter part no.	EMC filter ▲ part no.	mains choke part no.	motor choke part no.
	160★	1 x P	185	231	2/4	27.F5.A1P-B0_A	1 x 30.E5.T60-8001	1x 28.Z1.B06-1000	1 x 29.Z1.A04-1001
	200★	1 x P	225	281	2/4	28.F5.A1P-B0_A	1 x 30.E5.T60-8001	1x 28.Z1.B06-1000	1 x 29.Z1.A04-1001
	250★	1 x P	280	350	2/4	29.F5.A1P-B0_D	1 x 30.E5.T60-8001	1x 29.Z1.B06-1000	1 x 29.Z1.A04-1001
	315★	1 x P	345	438	2/4	30.F5.A1P-B0_A	1 x 30.E5.T60-8001	1x 30.Z1.B06-1000	1 x 29.Z1.A04-1001
	400★	2 x P	430	538	2/4	32.F5.A1P-B0_A	2 x 30.E5.T60-8001	2x 28.Z1.B06-1000	2 x 29.Z1.A04-1001
	450★	2 x P	500	613	2/4	33.F5.A1P-B0_D	2 x 30.E5.T60-8001	2x 29.Z1.B06-1000	2 x 29.Z1.A04-1001
	500★	2 x P	550	688	2/4	34.F5.A1P-B0_D	2 x 30.E5.T60-8001	2x 30.Z1.B06-1000	2 x 29.Z1.A04-1001
	560★	2 x P	620	763	2/4	35.F5.A1P-B0_D	2 x 30.E5.T60-8001	2x 30.Z1.B06-1000	2 x 29.Z1.A04-1001
	630★	3 x P	710	875	2/4	36.F5.A1P-B0_A	3 x 30.E5.T60-8001	3x 29.Z1.B06-1000	3 x 29.Z1.A04-1001
	710★	3 x P	820	1013	2/4	37.F5.A1P-B0_D	3 x 30.E5.T60-8001	3x 30.Z1.B06-1000	3 x 29.Z1.A04-1001
800★	3 x P	900	1100	2/4	38.F5.A1P-B0_D	3 x 30.E5.T60-8001	3x 30.Z1.B06-1000	3 x 29.Z1.A04-1001	
900★	3 x P	1015	1250	2/4	39.F5.A1P-B0_H	3 x 30.E5.T60-8001	3x 30.Z1.B06-1000	3 x 29.Z1.A04-1001	

▲ book-style (option)

★ mains choke generally required (page 26)

All units correspond to the 400 V type with regard to the technical functions and are universally suitable for the open-loop and closed-loop operation of asynchronous and synchronous motors.

Upon request the units are available for rated voltages of 3-phase 500 VAC and 3-phase 600 VAC.



### Generally:

Product standard	EN 61800-2, -5-1	Enclosure	IP 20 / VBG 4
Emitted interference	EN 61800-3	Storage temperature	-25 ... 70 °C
	EN 61000-6-1...4	Operation temperature	-10 ... 40 °C
		Short-circuit and earth fault monitoring	



## Safety in drive systems

The requirements of the safety regulations must be checked again for manufacturers of machines at the run-off of EN 954. At the latest of the extended transition period all start-ups must be carried out according to the new guidelines of ISO 13849 or IEC 62061.

Therefore **KEB** has added the new variant **F5-K** to the series **KEB COMBIVERT F5**, which is available for open-loop and closed-loop applications in the housings D-E-G-H-R-U-P-W. Function **STO** is met with the internal 2-channel optocoupler locking (no torque at the motor shaft, stop category 0 of EN 60204-1). Function **SS1** can be met in the wiring with external safety time-delay relay, when the drive inside an adjusted time is decelerated and set to **STO** (stop category 1 of EN 60204-1).

In the future **KEB COMBIVERT F5-K** meets the requirements of ISO 13849-1 in accordance with Performance Level PL-e and SIL 3 according to IEC 62061.

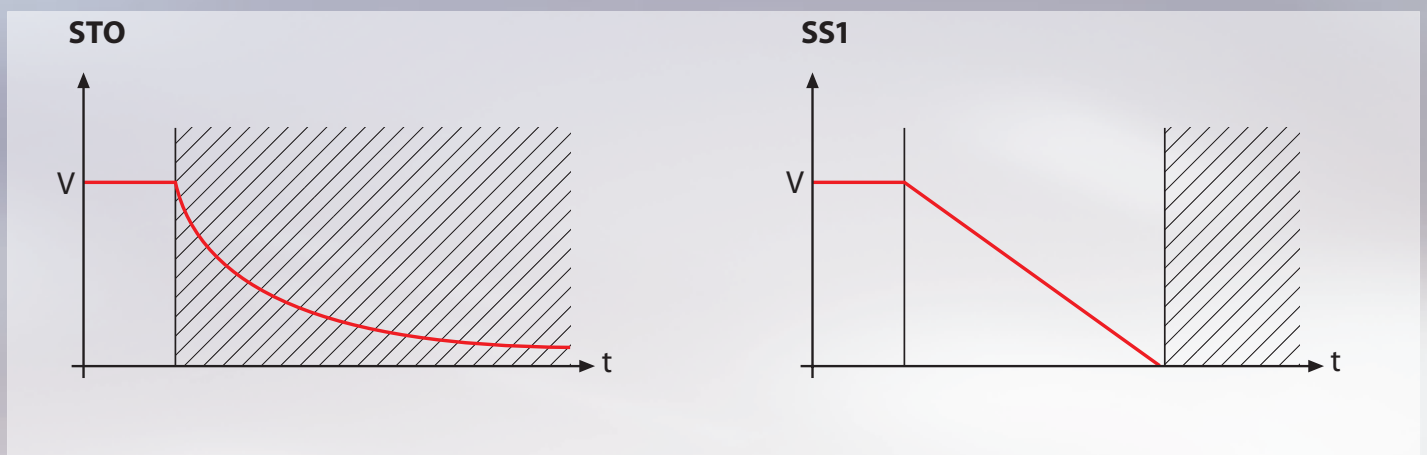

The adapted wiring of the control terminals occurs on a separate 10-pole plug-in connector. The also new 32-pole control terminal of the analog and digital inputs/outputs corresponds to the assignment of the inverter series **KEB COMBIVERT G6**.

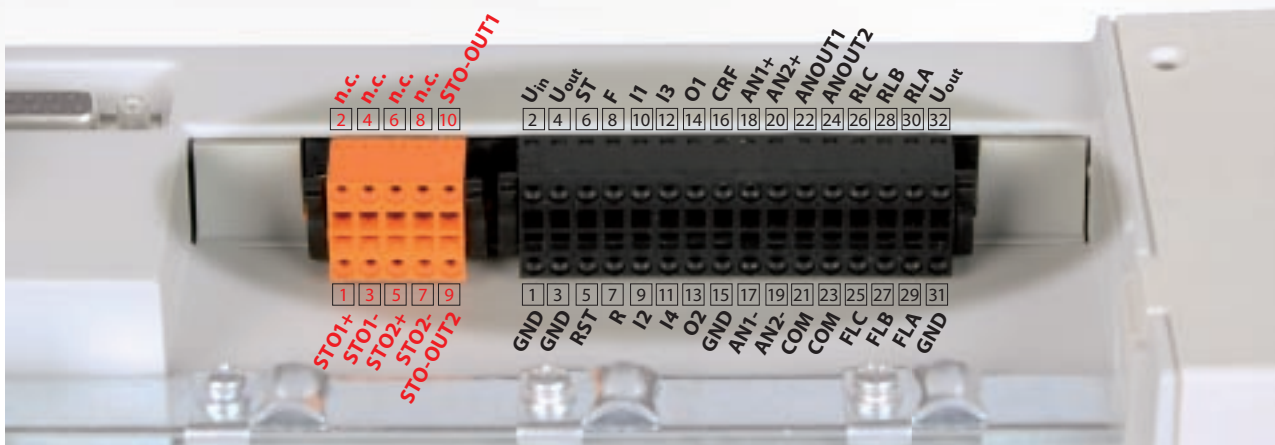

# KEB COMBIVERT F5 Multi encoder systems

## Encoder systems flexibly supported

**KEB COMBIVERT F5 Multi** operates all closed-loop tasks with a broad range of feedback cards for different encoder systems. The installation is done **factory made** according to the customer request (10th place part no. - page 9/10) or can be executed as re-fitting with the **KEB Encoder Kits**.

Encoder systems	factory-made installation part-code	Channel 1		Channel 2			KEB Encoder Kit	
		encoder type	connection	encoder type	mode	connection	D, E housing	G,H,R,U,W,P housing
	D	TTL	D-Sub 15-pole	TTL	Output	D-Sub 9-pole	1M.F5.K81-DZ19	2M.F5.K81-DZ19
	G	TTL	D-Sub 15-pole	TTL	Input	D-Sub 9-pole	1M.F5.K81-GZ18	2M.F5.K81-GZ18
	-	TTL	Terminal strip	TTL	Output	Terminal strip	1M.F5.K81-BZ05	2M.F5.K81-BZ05
	-	TTL	Terminal strip	TTL	Input	Terminal strip	1M.F5.K81-BZ04	2M.F5.K81-BZ04
	4	TTL	D-Sub 15-pole	SSI	Input	D-Sub 9-pole	1M.F5.K81-4Z15	2M.F5.K81-4Z15
	A	TTL	D-Sub 15-pole	Initiator	Input	Terminal strip	1M.F5.K81-AZ07	2M.F5.K81-AZ07
	7	TTL	D-Sub 15-pole	Tacho	Input	D-Sub 9-pole	-	2M.F5.K81-7Z09
	E	Resolver	D-Sub 15-pole	TTL	Output	D-Sub 9-pole	1M.F5.K81-EZ29	2M.F5.K81-EZ29
	H	Resolver	D-Sub 15-pole	TTL	Input	D-Sub 9-pole	1M.F5.K81-HZ28	2M.F5.K81-HZ28
	5	Resolver	D-Sub 15-pole	SSI	Input	D-Sub 9-pole	1M.F5.K81-5Z25	2M.F5.K81-5Z25
	X	HTL	Terminal strip	TTL	Output	Terminal strip	1M.F5.K81-XZ09	2M.F5.K81-XZ09
	W	HTL	Terminal strip	TTL	Input	Terminal strip	1M.F5.K81-WZ08	2M.F5.K81-WZ08
	J	HTL	D-Sub 15-pole	TTL	Output	D-Sub 9-pole	1M.F5.K81-JZ17	2M.F5.K81-JZ17
	K	HTL	D-Sub 15-pole	TTL	Input	D-Sub 9-pole	1M.F5.K81-KZ16	2M.F5.K81-KZ16
	S	HTL without inverse	Terminal strip	TTL	Output	D-Sub 9-pole	1M.F5.K81-SZ19	2M.F5.K81-SZ19
	T	HTL without inverse	Terminal strip	TTL	Input	D-Sub 9-pole	1M.F5.K81-TZ18	2M.F5.K81-TZ18
	8	HTL without inverse	Terminal strip	HTL	Output	Terminal strip	1M.F5.K81-8Z09	2M.F5.K81-8Z09
	-	HTL without inverse	Terminal strip	none	-	-	1M.F5.K8G-6Z07	2M.F5.K8G-6Z07
	L	HTL without inverse	D-Sub 15-pole	SSI	Input	D-Sub 9-pole	1M.F5.K81-LZ17	-
	M	SIN/COS	D-Sub 15-pole	TTL	Output	D-Sub 9-pole	1M.F5.K8G-MZ36	2M.F5.K8G-MZ26
	N	SIN/COS	D-Sub 15-pole	TTL	Input	D-Sub 9-pole	1M.F5.K8G-NZ35	2M.F5.K8G-NZ25
	1	SIN/COS	D-Sub 15-pole	SSI	Input	D-Sub 9-pole	1M.F5.K8G-1Z21	2M.F5.K8G-1Z21
	V	SSI-SIN/COS	D-Sub 15-pole	TTL	Output	D-Sub 9-pole	1M.F5.K8G-VZ27	2M.F5.K8G-VZ27
	U	SSI-SIN/COS	D-Sub 15-pole	TTL	Input	D-Sub 9-pole	1M.F5.K8G-UZ24	2M.F5.K8G-UZ24
	P	ENDAT	D-Sub 15-pole	TTL	Output	D-Sub 9-pole	1M.F5.K8G-PZ23	2M.F5.K8G-PZ23
	Q	ENDAT	D-Sub 15-pole	TTL	Input	D-Sub 9-pole	1M.F5.K8G-QZ22	2M.F5.K8G-QZ22
	3	ENDAT	D-Sub 15-pole	SSI	Input	D-Sub 9-pole	1M.F5.K8G-3Z20	2M.F5.K8G-3Z20
	-	ENDAT2.2 & BISS	Terminal strip	TTL	Output	Terminal strip	-	2M.F5.K8G-9Z09
	F	HIPERFACE	D-Sub 15-pole	TTL	Output	D-Sub 9-pole	1M.F5.K8G-FZ29	2M.F5.K8G-FZ29
	I	HIPERFACE	D-Sub 15-pole	TTL	Input	D-Sub 9-pole	1M.F5.K8G-IZ28	2M.F5.K8G-IZ28
	9	UVW	D-Sub 15-pole	TTL	Output	D-Sub 9-pole	1M.F5.K8G-9Z07	-
	Z	UVW	D-Sub 15-pole	TTL	Input	D-Sub 9-pole	1M.F5.K8G-ZZ08	2M.F5.K8G-ZZ08
	C	UVW	Terminal strip	HTL without inverse	Output	Terminal strip	-	2M.F5.K8G-CZ09

## Encoder cable for housing size A

cable type	inverter plug	encoder plug	length [m]	part no. ( __ length in [m])
<b>Resolver</b>	RJ45 male	12-pole	2 ... 40	00.F5.0C1-00__
<b>TTL</b>	RJ45 male	12-pole	2 ... 10	00.F5.0C1-30__
<b>Adapter</b>	RJ45 male	D-Sub 15-pole female	0.05	00.F5.0C0-0008
<b>Adapter</b>	RJ45 male	D-Sub 9-pole female	0.05	00.F5.0C0-0009
<b>Master-Slave</b>	RJ45 male	RJ45 male	0.5	00.F5.0C1-20P5

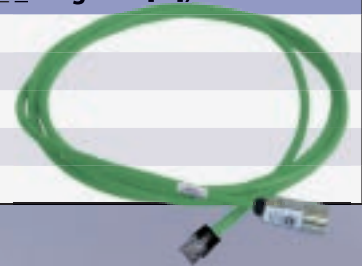

## Encoder cable for housing size D - E - G - H - R - U - W - P

cable type	inverter plug	encoder plug	length [m]	part no. ( __ length in [m])
<b>Resolver</b>	D-Sub 15-pole	12-pole	2 ... 30	00.F5.0C1-10__
<b>TTL</b>	D-Sub 15-pole	12-pole	2 ... 30	00.F4.109-00__
<b>TTL (channel 2)</b>	D-Sub 9-pole	12-pole	2 ... 30	00.F4.209-00__
<b>Hiperface</b>	D-Sub 15-pole	12-pole	2 ... 30	00.S4.809-00__
<b>EnDat</b>	D-Sub 15-pole	17-pole	2 ... 30	00.F5.0C1-40__
<b>TTL (no KEB motor)</b>	D-Sub 15-pole	free connecting cable	2 ... 30	00.F4.P09-00__
<b>TTL (channel 2) (no KEB motor)</b>	D-Sub 9-pole	free connecting cable	2 ... 30	00.F4.D09-00__
<b>Master-Slave</b>	D-Sub 9-pole male	D-Sub 9-pole male	1	00.F4.509-0001



Further lengths on request.

### Adapter

D-Sub 15-pole on terminal part no. AD.F4.Y72-0009

### MS-repeater for multi-master-slave applications

The signal amplifier prepares the incoming master signal in a way that the first signal is looped through and the second signal is measured and amplified!

part no. 00.F4.072-2008



cable type	inverter plug	encoder plug	length [m]	part no. ( __ length in [m])
<b>Master cable</b>	D-Sub 9-pole male	D-Sub 9-pole male	1	00.F4.509-0001
<b>Slave cable</b>	D-Sub 9-pole male	D-Sub 9-pole female	0.25	00.F4.409-0P25
<b>Slave cable</b>	D-Sub 9-pole male	D-Sub 9-pole female	0.5	00.F4.409-0P50
<b>Slave cable</b>	D-Sub 9-pole male	D-Sub 9-pole female	1	00.F4.409-0001

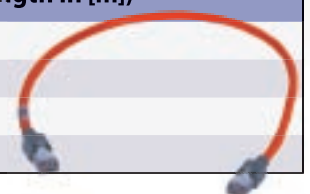

KEB encoder cables are twisted in pairs and double screened, in order to reach the best interference immunity.

## Asynchronous drive technology of the top class

F5-H (ASCL) is the result of long lasting model optimization of encoder-less field orientation and offers as result best speed and torque characteristics with asynchronous motors without encoder feedback.

### Properties

- high speed stability
  - load step response like closed-loop systems
  - torque accuracy typical  $< 3\% M_N$
  - display values with correction adjustment in the system „on the fly“
  - operation with output filters
  - low installation costs in case of loss of encoder cable, encoder and encoder interface
  - optimized efficiency in partial load range
- 
- **automatic adaption of the motor**
    - calibration routine of stator- and rotor resistance, main- and leakage inductance and dead time characteristic
    - thermal calculation in the motor model
  - **controller integration → symmetrical optimum**
    - simplifies the  $K_i/K_p$  calibration of the exterior closed circuit (speed)
    - only one parameter for drive optimization
    - speed preset
  - **exact torque display** by
    - determination of torque-offsets and elimination in the display
    - subtraction of no-load torque of the system (optional)

# ASCL

### Potential applications

- extruder main drives
- crusher drives / shredder
- centrifuges
- test bench / test systems
- stirring and mixer units
- meat cutter and mincer
- mixing plants
- heat pumps
- hydraulic pumps
- generators
- machine tools  
for wood, plastic, metal, ...

### Torque characteristic

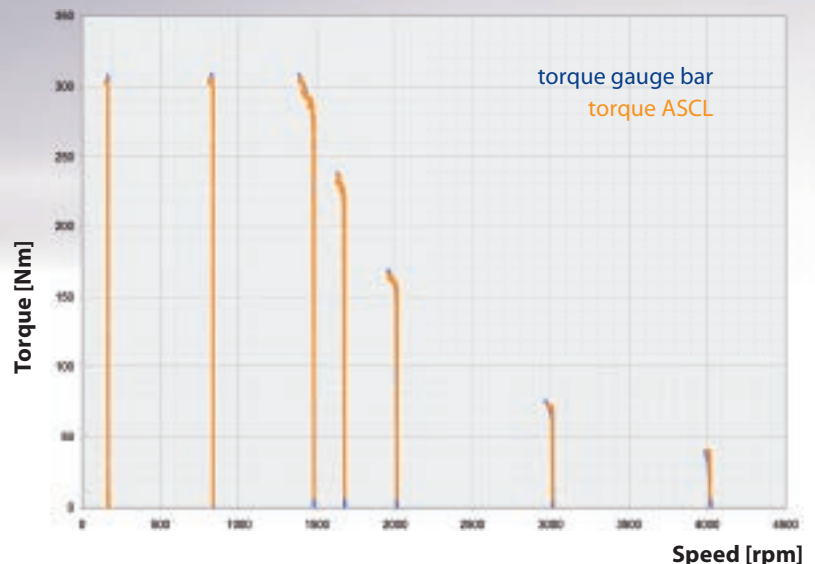

### Operation of synchronous motors without encoder feedback

The optimization of efficiency, available space and increasing dynamic forces the use of synchronous motors, which can be operated by **F5-E (SCL)** now without rotor position feedback in all applications without positioning tasks.

The calculated control method of the software has no effect through external disturbances and leads to high smoothness. Mechanically stressed motors, high frequency special machines or high-volume torque motors are operated more functional and safe with elimination of the encoder system.

#### Properties

- standstill position detection (calibration without rotation)
- operation with output filters
- low installation costs in case of loss of encoder line, encoder and encoder interface
- high dynamic / non-slip rotation
- reduced installation space / lower weight
- high efficiency / high availability



#### Potential applications

- driven tools in working stations
- synchronous process chain in textile machines
- hybrid drives
  - diesel electric drives in conveyor systems, container or heavy duty vehicles
  - electric drives in boats, yachts and vehicles
- synchronous extruder
- injection moulding technology / blow moulding technology
- high frequency pump drives in compressors, screws, vacuum pumps

#### Dynamic response behavior of a load



# KEB COMBIVERT F5 Assembly kit

## Frequency inverters KEB F5 COMBIVERT are flexible designed in a modular system and available in the following versions

- chassis unit of protection class IP 20 - universal mounting in the control cabinet
- chassis unit with factory mounted interference filter - unit-internal interference suppression
- chassis unit with factory mounted braking resistor - absorb pulse energy without additional required space, also available in combination with interference filter
- customer version FLAT-REAR - (**FR**) - direct thermal connection with cooling surfaces
- customer version LIQUID COOLED - (**LC**) liquid cooling
- customer version EXTERNAL HEAT - (**EH**) - through mounted heat sink for the thermal separation of the power unit

For customer-specific series-applications **KEB** provides complete solutions in the control cabinet installation in protection class IP 54.

Applied mounting points in a grid allow the use of prepared mounting plates.

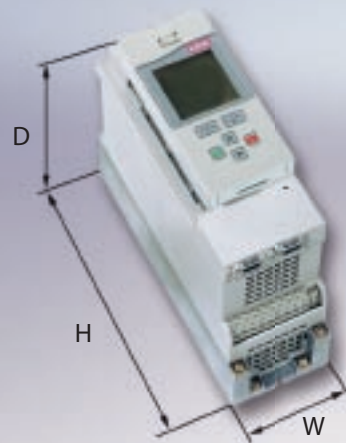

*compact...  
new defined!*





housing	installation version IP20 W x H x D (mm)			available customer versions		
	unit	with EMC filter	with resistor	FR	LC	EH
<b>A</b>	76 x 191 x 144	76 x 191 x 144		-	-	-
		76 x 216 x 184		-	-	-
<b>B</b>	90 x 220 x 160	90 x 249 x 200	90 x 220 x 190	●	-	●
<b>D</b>	90 x 250 x 181	90 x 285 x 221	90 x 250 x 211	●	-	●
<b>E</b>	130 x 290 x 208	132 x 352 x 258	130 x 290 x 238	●	●	●
<b>G</b>	170 x 340 x 255	181 x 415 x 311	170 x 340 x 280	●	●	●
<b>H</b>	297 x 340 x 255	300 x 445 x 321		●	●	●
<b>R</b>	340 x 520 x 355	340 x 520 x 355*		●	●	●
		110 x 478 x 115				
<b>U</b>	340 x 800 x 355	110 x 598 x 240		-	●	●
<b>P</b>	340 x 960 x 454	260 x 386 x 115		-	●	●
<b>W</b>	670 x 940 x 368	260 x 386 x 115 260 x 386 x 135		-	●	-

\* up to size 23.F5.

external unit

● customer version upon request



# Hardware specification KEB COMBIVERT F5

Control board Inverter housing		Basic	Compact	Multi		SCL		ASCL
		B ABDE	C BDEGHR	A A	A / K DEGHRUWP	E A	DEGHRUWP	H DEGHRUWP
Operating mode	open-loop	●	●	●	●	-	-	●
	closed-loop	-	-	●	●	●	●	●
	encoder-less closed-loop	-	-	-	-	●	●	●
	AC servo mode	-	-	●	●	●	●	●
	flux vector mode	-	-	●	●	●	●	●
	encoder-less vector mode (KEB SMM - sensorless motor management)	●	●	●	●	-	-	●
	standard v/f mode	●	●	●	●	-	-	●
Control board	voltage supply	internal	internal	external	internal	external	internal	internal
	int. voltage supply (100 mA max)	24 VDC	24 VDC	-	24 VDC	-	24 VDC	24 VDC
	24 V DC supply external	no	yes	yes	yes	yes	yes	yes
	I/O scan time	2 ms	2 ms	1 ms	1 ms	1 ms	1 ms	1 ms
	number of terminals	17	29	17	29	17	29	29
	pluggable control terminals	yes	yes	yes	yes	yes	yes	yes
Digital	number	5	8	5	8	5	8	8
	specification <i>adjustable</i>	PNP - (13..30 VDC)	PNP/NPN ● (10..30 VDC)	PNP - (13..30 VDC)	PNP/NPN ● (10..30 VDC)	PNP - (13..30 VDC)	PNP/NPN ● (13..30 VDC)	PNP/NPN ● (13..30 VDC)
Input Analog	number	1	2	1	2	1	2	2
	specification <i>0 ... 10 V; ± 10 V</i> <i>0 ... 20 mA / 4 ... 20 mA</i> <i>potential-free</i>	● - (single-ended)	● ● ●	● - ●	● ● ●	● - ●	● ● ●	● ● ●
	resolution	11bit	12 bit	11 bit	12 bit	11 bit	12 bit	12 bit
	fast scan time	no	250 µs	250 µs	250 µs	250 µs	250 µs	250 µs
	sample and hold mode	yes	yes	yes	yes	yes	yes	yes
Output Relay	number	0	2	2	2	2	2	2
	specification open-collector (50 mA total)	-	●	●	●	●	●	●
	number	2	2	1	2	1	2	2
	specification potential-free (30 V DC / 1 A)	●	●	●	●	●	●	●
	number	1	2	1	2	1	2	2
	specification <i>0 ... 10 V; ± 10 V</i>	● (5 mA)	● 2x (5 mA)	● (5 mA)	● 2x (5 mA)	● (5 mA)	● 2x (5 mA)	● 2x (5 mA)
resolution	11 bit	11 bit	11 bit	11 bit	11 bit	11 bit	11 bit	
Encoder feedback		-	-	standard	option card	standard	option card	option card
	2 encoder inputs	-	-	●	●	●	●	●
	positioning to second encoder	-	-	●	●	●	●	●
	encoder emulation TTL output	-	-	●	●	●	●	●
	analog encoder	-	-	Resolver	Resolver SIN/COS UVW encoder Tacho generator	Resolver	Resolver SIN/COS UVW encoder Tacho generator	Resolver SIN/COS UVW encoder Tacho generator
	digital encoder	-	-	TTL	TTL HTL Initiator	TTL	TTL HTL Initiator	TTL HTL Initiator
	serial encoder (single- and multi-turn)	-	-	-	BiSS ENDAT HIPERFACE SSI SSI-SIN/COS	-	BiSS ENDAT HIPERFACE SSI SSI-SIN/COS	BiSS ENDAT HIPERFACE SSI SSI-SIN/COS

● included

Control board inverter housing	Basic	Compact	Multi		SCL		ASCL
	B ABDE	C BDEGHR	A A	A / K DEGHRUWP	E A	E DEGHRUWP	H DEGHRUWP
<b>Speed mode</b>	Hz	Hz	Hz, rpm	Hz, rpm	Hz, rpm	Hz, rpm	Hz, rpm
separate S-curve ACC/DEC	●	●	●	●	●	●	●
separate lower/upper S-curve times	-	-	●	●	●	●	●
sep. acceleration time for counter clockwise-/clockwise rotation	●	●	●	●	●	●	●
sep. deceleration time for counter clockwise-/clockwise rotation	●	●	●	●	●	●	●
ogive function	-	-	●	●	●	●	●
speed search (aligning the motor)	●	●	●	●	●	●	●
fast analog input	●	●	●	●	●	●	●
2 analog inputs with prog. function	-	●	-	●	-	●	●
fixed speed / fixed frequency	4	4	4	4	4	4	4
fixed speed / fixed frequency with set-programming	16	32	16	32	16	32	32
<b>Positioning mode</b>							
simple repeatable positioning without encoder	●	●	-	-	-	-	-
positioning via motor encoder	-	-	●	●	-	-	-
positioning via external encoder	-	-	●	●	-	-	-
positioning without encoder	-	-	-	-	-	-	-
position value resolution	-	-	32 bit	32 bit	-	-	-
internally storable positions	-	-	32	32	-	-	-
analog setpoint setting for target position	-	-	●	●	-	-	-
different reference routines	-	-	●	●	-	-	-
limit switch protection	-	-	●	●	-	-	-
relative-/absolute positioning	-	-	●	●	-	-	-
interruption in the positioning	-	-	●	●	-	-	-
rotary table positioning	-	-	●	●	-	-	-
rotary table positioning with shortest path	-	-	●	●	-	-	-
contouring with bus	-	-	●	●	-	-	-
<b>Synchronisation mode</b>	-	-	●	●	-	-	-
angle synchronisation	-	-	●	●	-	-	-
speed synchronisation	-	-	●	●	-	-	-
programmable gearshifts	-	-	8	8	-	-	-
gearshift via analog input	-	-	●	●	-	-	-
angle adjustment	-	-	●	●	-	-	-
synchronisation with constant distance or ramp	-	-	●	●	-	-	-
<b>Torque mode</b>	-	-	●	●	●	●	●
adjustable torque for all operating conditions	-	-	●	●	●	●	●
adjustable torque for ACC/DEC	-	-	●	●	●	●	●
adjustable torque for motor/regen operation	-	-	●	●	●	●	●
analog torque setting	-	-	●	●	●	●	●
fast analog torque setting	-	-	250 µs	250 µs	250 µs	250 µs	250 µs
acceleration at torque limit	-	-	●	●	●	●	●
<b>Functions</b>							
PID process control	●	●	●	●	●	●	●
automatic motor identification	-	-	●	●	●	●	●
automatic rotor position detection in standstill	-	-	●	●	●	●	●
torque precontrol	-	-	●	●	●	●	●
brake control / handling	●	●	●	●	●	●	●
power off / braking without mains voltage	●	●	●	●	●	●	●
programmable restart-starting conditions	-	-	●	●	●	●	●
programmable timer/counter (sec/h/inc)	2	2	2	2	2	2	2
max. input frequency of the counter	250 Hz	250 Hz	500 Hz	500 Hz	500 Hz	500 Hz	500 Hz

● included

## Unified Drive Platform...

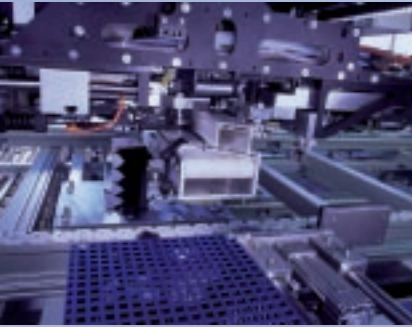

Based on the modular sub-assembly of the **KEB COMBIVERT F5** series **KEB** develops in close collaboration with the OEM user adapted drive systems for series machines.

With long experiences in tasks of the

- packaging industry
- textile industry
- plastic industry
- printing- / paper industry
- woodworking
- storage and transport technology
- lift industry

we integrate customer specific software modules or modified hardware for our customers, e.g. as

- state - machine,  
i.e. complete functional sequences are stored in the inverter
- adaption to special serial protocols
- industry-specific software e.g. spindle drives
- flexible cooling systems for air and water
- complete switchgear systems



**FR** (Flat Rear)



**EH** (External Heat)



**LC** (Liquid Cooled)

### Single axis solutions with KEB open operator



Economical programmable hardware for customer-specific software extensions in single axis applications (C- / assembler programming, free flash memory: 64 k, RS 232/485 interface) e.g. load control for crane drives, storage or transport drives, lift-specific data input, extended input and output functions.

### Multi-axis solutions



A functional unit is available with **KEB COMBICONTROL C5**, which is designed as drive control for drive tasks with Soft PLC, Soft-Motion or CNC functionality between conventional PLC and drive level or which replaces completely the conventional PLC.

A cost-effective serial communication occurs by using the unit-internal HSP5-interface of the **KEB COMBIVERT F5**.

The result is a free-programmable, universal and economical automation system according to IEC 61131-3 which is designed for all open-loop and closed-loop systems.



The drive control in combination with **KEB COMBIVERT F5 Multi** operates directly 4 or 8 standard drives in a synchronous real-time clock of 1 ms, which can be used for high priority traction controls.

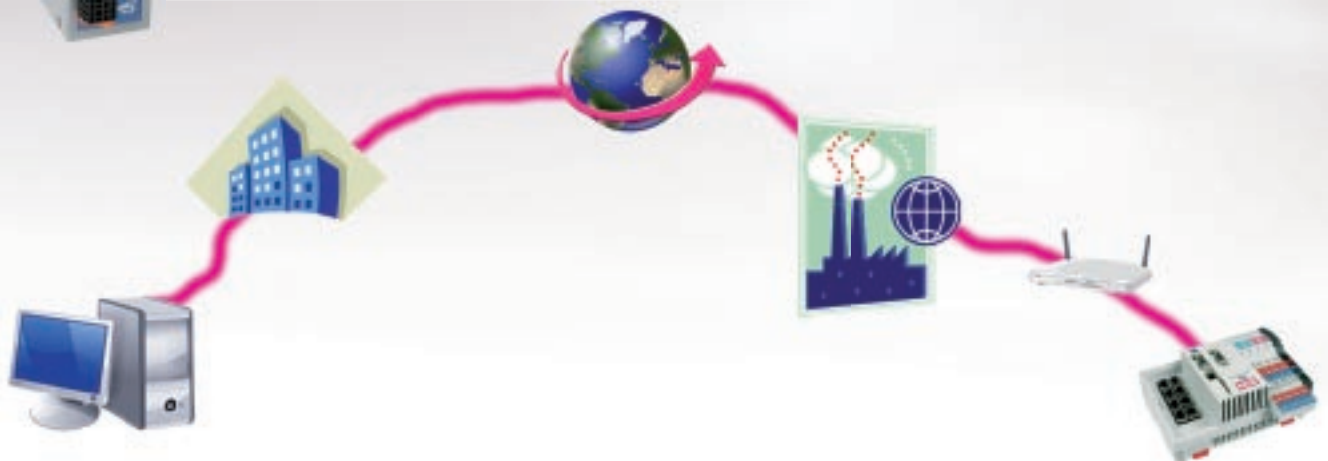

The standard Ethernet interface provides the basis for remote control solutions, integration of HMI modules or I/O options.

## Plaintext operation

### LCD operator, part no. 00.F5.060-K000

equipped with 6-language plaintext display and menu-controlled keyboard operation as plug-in module for all **KEB COMBIVERT F5** units.

The memory function allows **storing** and **loading** of complete parameter settings by calling the settings from the internal flash or plug-in SD- / MMC memory card.



### Digital operator, part no. 00.F5.060-1000

display and keyboard operation, plug-in module, prepared in connection with the ready-made **HSP5 operator 00.F5.060-9000** + **cable 00.F5.0C0-2030** (3 m) / **-2100** (10 m) for external use as remote operator.



**Universal PC software for all KEB COMBIVERT F5 units**

- complete management of unit settings
- display and adjustment of all parameters in up to 8 sets
- display of physical values and monitoring of operating data
- configuration of a customer-specific default setting in the „CP-level“
- analysis/monitoring of the communication between drive and control parallel to the field bus operation

Analysis

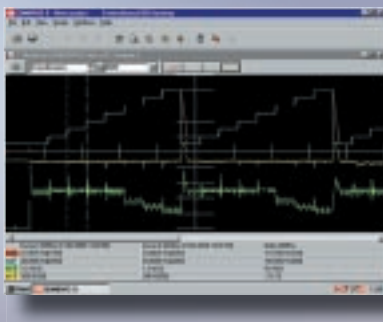

Parameterization

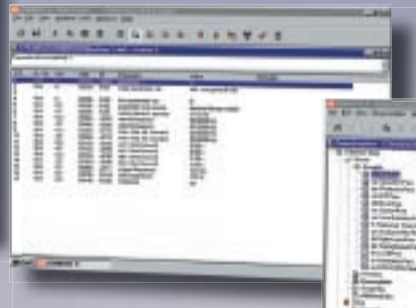

Display

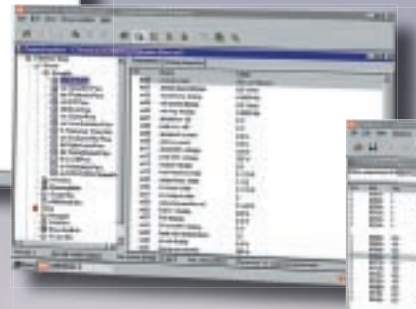

Project administration

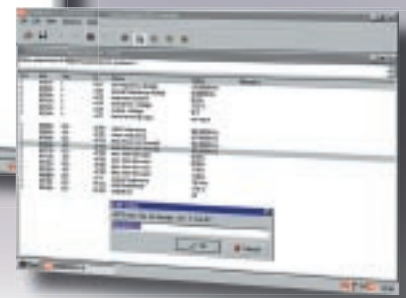

Available as **KEB COMBIVIS 5**-/ DVD with part no. **CD.SW.010-0100**

or as actual file in the **INTERNET** under <http://www.keb.de>



**Accessories:**

**KEB COMBIVIS** interface cable RS 232 / part no. **00.58.025-001D**  
(in combination with interface operator **00.F5.060-2000**)

KEB service cable HSP5 / part no. **00.F5.0C0-0010** (1,8 m) +  
HSP5 adapter **00.F5.0C0-0020** (0,4 m)  
for connections to the diagnostic / service interface.

# Operation and display

## Serial communication



Profibus operator, **part no. 00.F5.060-3000 / -3100**  
slave connection up to 12,5 MBaud,  
IN/OUT connection D-Sub 9-pole,  
service interface for HSP5 adapter  
accessory driver software for S7 02.B0.0SW-S710



InterBus operator, **part no. 00.F5.060-4000**  
InterBus-remote bus  
IN/OUT connection D-Sub 9-pole,  
service interface for HSP5 adapter



CAN operator, **part no. 00.F5.060-5010 / -5110**  
CANopen profile DS 301 (DS 402),  
IN/OUT connection D-Sub 9-pole  
service interface for HSP5 adapter  
(upon request: version with plug-in terminal strip)



Sercos operator, **part no. 00.F5.060-6001**  
SERCOS IN/OUT/FSMA connection  
service interface for HSP5 adapter

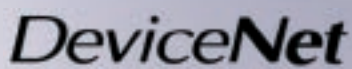

DeviceNet operator, **part no. 00.F5.060-7000**  
IN/OUT connection open entry,  
service interface for HSP5 adapter



MODBUS operator, **part no. 00.F5.060-A000**  
D-Sub 9-pole (female) connection  
service interface for HSP5 adapter

**Interface operator, part no. 00.F5.060-2000 /-2100**  
universal open KEB protocol for PC and PLC connection  
RS 232/485 connection D-Sub 9-pole





**Ethernet-based solutions**



Ethernet operator, **part no. 00.F5.060-8000**  
 IEEE 802.3 10Base-T (10 Mbaud)  
 2 x RJ45 connection  
 service interface for HSP5 adapter

**Ethernet**  
 TCP/IP

EtherCAT operator, **part no. 00.F5.060-F000**  
 2 x RJ45 connection  
 service interface for HSP5 adapter

**EtherCAT**®

Powerlink operator, **part no. 00.F5.060-H000**  
 2 x RJ45 connection  
 service interface for HSP5 adapter

ETHERNET ■ ■ ■ ■ ■  
**POWERLINK**

Profinet operator, **part no. 00.F5.060-L100**  
 2 x RJ45 connection  
 service interface for HSP5 adapter

**PROFI**®  
 INDUSTRIAL ETHERNET  
**NET**

EtherNet/IP operator, **part no. 00.F5.060-M100**  
 2 x RJ45 connection  
 service interface for HSP5 adapter

**EtherNet/IP**™

Accessories for the HSP5 service interface of the operators:  
**HSP5 adapter,**  
**part no. 00.F5.0C0-0020**  
 in combination with service cable  
**part no. 00.F5.0C0-0010**

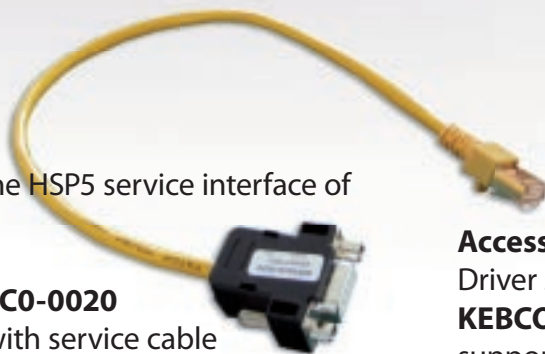

**KEB-HSP 5 /  
 DIN 66019-II**

**Accessory**

Driver software for WIN 95/98/NT/2000/XP  
**KEBCOM, part no. FD.SW.020-0100**  
 supports the PC connection for the protocols  
 KEB DIN 66019-II, KEB-HSP5, InterBus and TCP/IP

## Stable operation in industrial environments

An EMC-compliant assembly with efficient control cabinet and suppression system is the basis for safe operation of machinery and equipment. The current and voltage limiting **KEB COMBILINE** modules are optimally designed to meet the requirements of the KEB COMBIVERT F5 inverter series and support the use through

- **Mains EMC filters** - reduce the cable-fed emission to the required limits IEC 61800... - C1/C2. Further variants offer small leakage currents or the operation of special line form.
- **Mains choke** - reduce the input current draw and the system perturbation.
- **Output choke and -filters** - reduce the voltage and current load of the motor winding.
- **Input/output filters** - space-saving combination, consistently adapted and optimized to the drive controller.
- **Sine-wave filters** - protection of the motor winding against voltage peaks, use of long motor lines and reduction of shielded motor cables.
- **Harmonic filters** reduce the system perturbation from low frequency interferences from B6-rectifier supplied devices. These harmonic filters are the new innovative solution, which can be designed already in the electrical switching station in the planning phase (simple like a mains choke) and they enable compliance with many international standards.

## EMC service

- means mobile, direct field assistance
- advising in the planning phase
- analysis of existing systems

and is one of our contributions in the design of system solutions

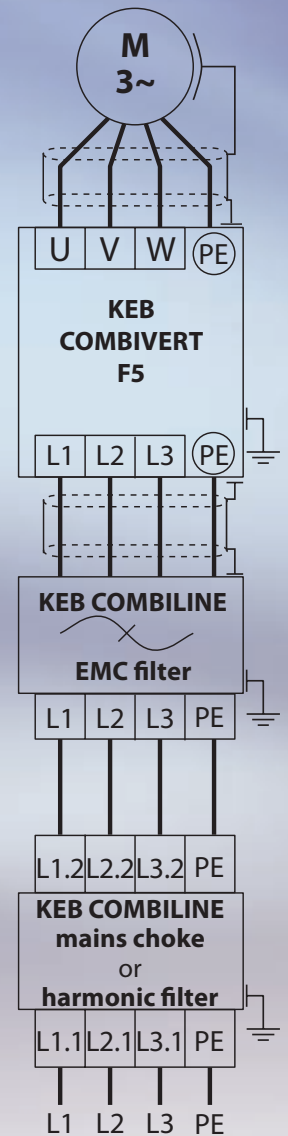

	P <sub>N</sub> [kW]	housing	EMC filter	mains choke	harmonic filter	motor choke	sine-wave filter
					THD <sub>(i)</sub> ≤ 8 %	≤ 50 Hz	≤ 100 Hz
230 V class	0.37	A	07.U5.B0A-1000* 1)	05.DR.F08-4951*	upon request	05.DR.A08-4251	
	0.75	A	07.U5.B0A-1000* 1)	07.DR.F08-2951*		07.DR.A08-2851	
	0.75	B	07.U5.B0B-1010*	07.DR.F08-2951*		07.DR.A08-2851	
	1.5	B	10.U5.B0B-1000*	09.DR.F08-1851*		09.DR.A08-2151	
	2.2	B	10.U5.B0B-1000*	10.DR.F08-1551*		10.DR.A08-1551	
	4	D	12.U5.B0D-2000	12.DR.A08-8541		12.DR.A08-8541	upon request
	5.5	E	13.U5.B0E-2000	13.DR.A08-5641		13.DR.A08-5641	
	7.5	E	14.U5.B0E-2000	14.DR.A08-4241		14.DR.A08-4241	
	11	G	15.U5.B0G-2000	15.DR.A08-2841		15.DR.A08-2841	
	15	H	16.U5.B0H-2000	16.DR.A08-2241		16.DR.A08-2241	
400 V class	0.37	A	Basic internal, Multi footprint	03.DR.B08-1461	09.Z1.C04-1000	03.DR.B08-1461	05.Z1.G04-1000
	0.37	B	10.U5.B0B-3000	03.DR.B08-1461	09.Z1.C04-1000	03.DR.B08-1461	07.Z1.G04-1000
	0.75	A	Basic internal, Multi footprint	07.DR.B08-4951	09.Z1.C04-1000	07.DR.B08-4951	07.Z1.G04-1000
	0.75	B	10.U5.B0B-3000	07.DR.B08-4951	09.Z1.C04-1000	07.DR.B08-4951	07.Z1.G04-1000
	1.5	A	Basic internal, Multi footprint	07.DR.B08-4951	09.Z1.C04-1000	07.DR.B08-4951	09.Z1.G04-1000
	1.5	B	10.U5.B0B-3000	07.DR.B08-4951	09.Z1.C04-1000	07.DR.B08-4951	09.Z1.G04-1000
	2.2	B	10.U5.B0B-3000	10.DR.B08-3751	12.Z1.C04-1000	10.DR.B08-3751	10.Z1.G04-1000
	4	B	12.U5.B0B-3000	12.DR.B08-2851	12.Z1.C04-1000	12.DR.B08-2851	12.Z1.G04-1000
	5.5	D	13.U5.B0D-3000	13.DR.B08-1851	13.Z1.C04-1000	13.DR.B08-1851	13.Z1.G04-1000
	7.5	D	14.U5.B0D-3000	14.DR.B08-1451	14.Z1.C04-1000	14.DR.B08-1451	14.Z1.G04-1000
	11	E	15.U5.B0E-3000	15.DR.B08-9841	15.Z1.C04-1000	15.DR.B08-9841	15.Z1.G04-1000
	15	E	16.U5.B0E-3000	16.DR.B08-7341	16.Z1.C04-1000	16.DR.B08-7341	16.Z1.G04-1000
	18.5	G	17.U5.B0G-3000	17.DR.B08-5941	17.Z1.C04-1000	17.DR.B08-5941	17.Z1.G04-1000
	22	G	18.U5.B0G-3000	18.DR.B18-4941	18.Z1.C04-1000	18.DR.B18-4941	18.Z1.G04-1000
	30	H	19.U5.B0H-3000	19.DR.B18-3941	19.Z1.C04-1000	19.DR.B18-3941	19.Z1.G04-1000
	37	H	20.U5.B0H-3000	20.DR.B18-3341	20.Z1.C04-1000	20.DR.B18-3341	20.Z1.G04-1000
	45	R	23.U5.B0R-3000	21.DR.B18-2841	21.Z1.C04-1000	21.DR.B18-2841	21.Z1.G04-1000
	55	R	23.U5.B0R-3000	22.Z1.B04-1000	22.Z1.C04-1000	22.Z1.B04-1000	22.Z1.G04-1000
	75★	R	23.U5.B0R-3000	23.Z1.B04-1000	23.Z1.C04-1000	23.Z1.B04-1000	23.Z1.G04-1000
	90★	U	25.U5.B0U-3000	24.Z1.B04-1000	24.Z1.C04-1000	24.Z1.B04-1000	24.Z1.G04-1000
	110★	U	25.U5.B0U-3000	25.Z1.B04-1000	25.Z1.C04-1000	25.Z1.B04-1000	25.Z1.G04-1000
	132★	U	27.U5.B0U-3000	26.Z1.B04-1000	26.Z1.C04-1000	26.Z1.B04-1000	26.Z1.G04-1000
	160★	U	27.U5.B0U-3000	27.Z1.B04-1000	27.Z1.C04-1000	27.Z1.B04-1000	27.Z1.G04-1000
	200★	P	28.U5.A0W-3000	28.Z1.B04-1000	28.Z1.C04-1000	28.Z1.B04-1000	28.Z1.G04-1000
	250★	P	30.U5.A0W-3000	29.Z1.B04-1000	29.Z1.C04-1000	29.Z1.B04-1000	29.Z1.G04-1000
	315★	W	30.U5.A0W-3000	2 x 27.Z1.B04-1000	2 x 27.Z1.C04-1000	30.Z1.B22-4430	30.Z1.G04-1000
	355★	W	32.U5.A0W-3000	2 x 28.Z1.B04-1000	2 x 27.Z1.C04-1000	31.Z1.A04-1000	
	400★	W	32.U5.A0W-3000	2 x 28.Z1.B04-1000	2 x 28.Z1.C04-1000	2 x 29.Z1.A04-1001	
450★	2 x P	2 x 28.U5.A0W-3000	2 x 28.Z1.B04-1000	2 x 28.Z1.C04-1000	2 x 29.Z1.A04-1001		
500★	2 x P	2 x 30.U5.A0W-3000	2 x 29.Z1.B04-1000	2 x 29.Z1.C04-1000	2 x 29.Z1.A04-1001		
560★	3 x P	3 x 28.U5.A0W-3000	3 x 28.Z1.B04-1000	3 x 28.Z1.C04-1000	2 x 29.Z1.A04-1001	upon request	
630★	3 x P	3 x 30.U5.A0W-3000	3 x 28.Z1.B04-1000	3 x 28.Z1.C04-1000	3 x 29.Z1.A04-1001		
710★	3 x P	3 x 30.U5.A0W-3000	3 x 29.Z1.B04-1000	3 x 29.Z1.C04-1000	3 x 29.Z1.A04-1001		
800★	3 x P	3 x 30.U5.A0W-3000	3 x 29.Z1.B04-1000	3 x 29.Z1.C04-1000	3 x 29.Z1.A04-1001		

\* 1-phase 230 V AC; 3-phase filter and chokes upon request 1) F5 Multi

★ mains choke generally required

# KEB COMBILINE Braking resistors

**KEB braking resistors** - supplied with thermal monitoring as standard for the absorption of generated energy. Quiet braking available in compact sub-mounted modules to absorb pulse energy or universal side-mounted units.

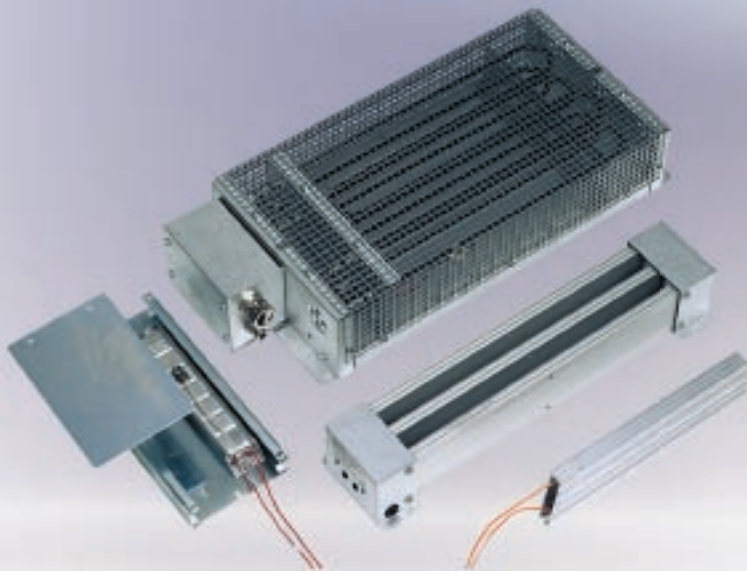
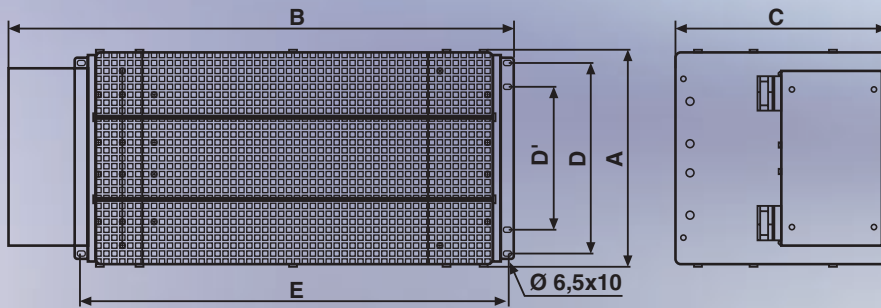
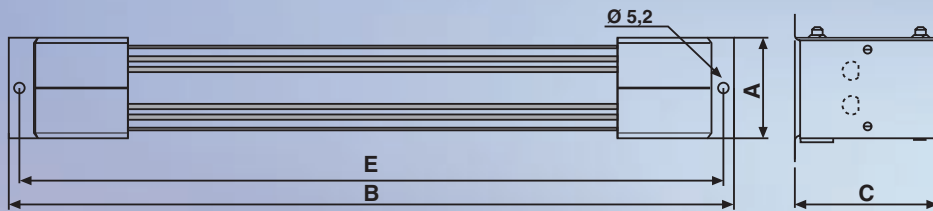

Increasing the system efficiency or for high regenerated energy use **KEB COMBIVERT R6** regenerative units, available for block or sinusoidal line currents in the power range up to 900 kW.



	part no.	External braking resistors										required modules
		R [Ω]	P <sub>D</sub> [W]	P <sub>6</sub> [W]	P <sub>25</sub> [W]	P <sub>40</sub> [W]	A [mm]	B [mm]	C [mm]	D/D' [mm]	E [mm]	
230 V class	07.BR.100-1180	180	44	800	300	180	40	165	26	-	145	OHM-A
	09.BR.100-1100	100	82	1500	500	300	40	240	26	-	225	
	10.BR.100-1683	68	120	2200	800	500	40	300	26	-	285	
	12.BR.100-1333	33	250	4200	1300	750	80	300	28	-	285	
	13.BR.100-1273	27	300	5100	1500	900	80	400	28	-	385	
	14.BR.100-1203	20	410	6900	1800	1100	80	400	28	-	385	
	15.BR.110-1133	13	630	10000	3200	1800	63	370	96	-	355	
	16.BR.110-1103	10	780	14000	3600	2200	63	470	96	-	455	
	17.BR.110-1073	7	1200	22000	5400	3100	90	470	96	50	455	
400 V class	07.BR.100-6620	620	56	900	300	180	40	165	26	-	145	OHM-B
	09.BR.100-6390	390	90	1500	500	300	40	240	26	-	225	
	10.BR.100-6270	270	130	2100	800	500	40	300	26	-	285	
	12.BR.100-6150	150	230	3850	1300	750	80	300	28	-	285	
	13.BR.100-6110	110	350	5000	1500	900	80	400	28	-	385	
	14.BR.100-6853	85	410	6900	1800	1100	80	400	28	-	385	
	15.BR.110-6563	56	620	10000	3200	1800	63	370	96	-	355	
	16.BR.110-6423	42	820	14000	3600	2200	63	470	96	-	455	
	17.BR.110-6303	30	1200	19000	5400	3100	90	470	96	50	455	
	18.BR.226-6203	20	1700	29000	7500	4500	270	625	116	240/176	526	
	19.BR.226-6152	15	2300	38000	10000	6000	270	625	116	240/176	526	
	20.BR.226-6123	12	2900	48000	12500	7500	270	625	223	240/176	526	
	21.BR.226-6103	10	3000	53000	15000	9000	270	625	223	240/176	526	
	22.BR.226-6866	8.6	4000	68000	17500	10000	270	625	273	240/176	526	
	23.BR.226-6676	6.7	5200	86000	22000	12500	270	625	273	240/176	526	
	24.BR.226-6506	5	6900	115000	30000	18000	270	625	223	240/176	526	
	25.BR.226-6436	4.3	8100	135000	35000	20000	270	625	273	240/176	526	
	26.BR.226-6386	3.8	9200	154000	40000	22500	270	625	273	240/176	526	
	27.BR.226-6336	3.3	10000	173000	45000	25000	270	625	273	240/176	526	
	28.BR.226-6226	2.2	15000	260000	67000	37000	270	625	273	240/176	526	
29.BR.226-6176	1.7	20000	340000	90000	50000	270	625	273	240/176	526		
30.BR.226-6136	1.3	26000	440000	112000	62000	270	625	273	240/176	526		

P<sub>D</sub> continuous rating  
 P<sub>6</sub> pulse rating with 6 sec. ON-time and period of 120 sec.  
 P<sub>25</sub> pulse rating with 25 sec. ON-time and period of 120 sec.  
 P<sub>40</sub> pulse rating with 40 sec. ON-time and period of 120 sec.

# Motor Technology

Optimally harmonized

- **synchronous motors** with nominal torque **up to 100 Nm** and
- **asynchronous motors** with nominal power **up to 160 kW**

convert the output signals of the drive controller **KEB COMBIVERT F5** in rotation.

**KEB** provides efficient series of motors for inverter operation depending on the physical requirements of the application, mechanical housings, inertia ratio motor/machine and/or overload characteristic.

If desired you get complete systems consisting of frequency inverter/servo controller and motor. The initial setting is available worldwide via web based motor configurator (**www.keb.de**).

Detailed information on features, performance and technical data available in the **KEB SERVO MOTORS** catalogue.

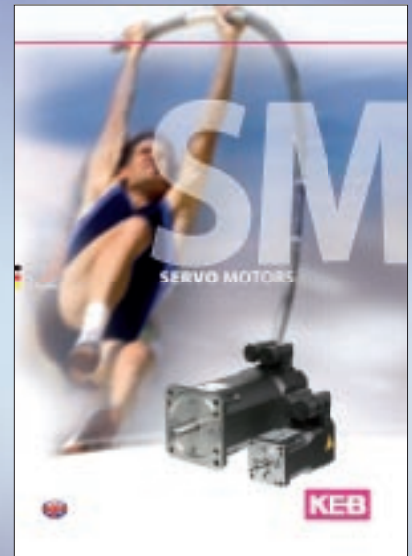

Motor configurator

Motor type	Type series	KEB Art.-No.	$U_{nom} / V$	$P_{nom} / kW$	$T_{nom} / Nm$	$f_{max} / Hz$	$n_{max} / rpm$	$i_L / A$	Available encoders
Synchronous	Dynamic Line I	+ 41.5H.00x-82xx	120	0.3	1.0	1.3	8000	0.67	Resolver, 8-Interface SE336 ...
Synchronous	Dynamic Line I	+ 42.5H.00x-82xx	120	0.3	1.3	1.3	8000	0.24	Resolver, 8-Interface SE336 ...
Synchronous	Dynamic Line I	+ 43.5H.00x-82xx	120	0.8	2.0	2.0	8000	0.31	Resolver, 8-Interface SE336 ...
Synchronous	Dynamic Line I	+ 44.5H.00x-82xx	120	0.8	2.8	3.2	8000	0.48	Resolver, 8-Interface SE336 ...
Synchronous	Dynamic Line I	+ 45.5H.00x-42xx	120	0.8	2.0	1.9	8000	0.22	Resolver, 8-Interface SE332 ...
Synchronous	Dynamic Line I	+ 46.5H.00x-82xx	120	0.8	2.8	2.6	8000	0.22	Resolver, 8-Interface SE332 ...
Synchronous	Dynamic Line I	+ 47.5H.00x-42xx	120	1.3	3.8	3.3	4000	0.36	Resolver, 7-Interface SE332 ...
Synchronous	Dynamic Line I	+ 48.5H.00x-82xx	120	2.2	4.4	4.0	4000	0.36	Resolver, 7-Interface SE332 ...
Synchronous	Dynamic Line I	+ 49.5H.00x-82xx	120	2.0	4.7	5.5	4000	0.57	Resolver, 7-Interface SE332 ...
Synchronous	Dynamic Line I	+ 50.5H.00x-82xx	120	2.8	6.6	7.7	6000	0.57	Resolver, 7-Interface SE332 ...
Synchronous	Dynamic Line I	+ 51.5H.00x-22xx	120	0.8	1.4	1.8	3000	1.20	Resolver, 8-Interface SE332 ...
Synchronous	Dynamic Line I	+ 52.5H.00x-42xx	120	0.8	1.8	2.0	4000	1.20	Resolver, 7-Interface SE332 ...
Synchronous	Dynamic Line I	+ 53.5H.00x-82xx	120	0.7	2.4	3.0	8000	1.20	Resolver, 8-Interface SE332 ...



Industrial gear motors ensure the optimization of speed and torque. With the **KEB COMBIGEAR** program, a fully modular system is available in

- **helical inline-**
- **helical shaft mounted-**
- **helical bevel-**
- **helical worm gear**

Key features of the range are the finely graduated ratios, compact constructions and robust cast iron housings.

Tuned to the **KEB COMBIVERT F5** inverter, these units are ideal for complete system solutions **up to 55 kW**.

High dynamics combined with minimal backlash are the main requirements for servo applications. **KEB synchronous motors** in combination with powerful **planetary gears** or the gearboxes from the **KEB COMBIGEAR** range fulfill these requirements to give a cost effective solution.

With **KEB DRIVE**, an efficient product configurator is available for the selection of the optimal variant for your applications.



# Headquarters

**Karl E. Brinkmann GmbH**  
Försterweg 36 - 38  
D-32683 Barntrup  
Internet: [www.keb.de](http://www.keb.de)

Tel.: + 49 (0) 5263 401-0  
Fax: + 49 (0) 5263 401-116  
E-mail: [info@keb.de](mailto:info@keb.de)

## COMPANIES

### AUSTRIA

KEB Antriebstechnik  
Austria GmbH  
Ritzstraße 8  
A - 4614 Marchtrenk  
Tel.: +43 (0)7243 53586-0  
Fax: +43 (0)7243 53586-21  
E-mail: [info@keb.at](mailto:info@keb.at)  
Internet: [www.keb.at](http://www.keb.at)

### CHINA

KEB Power Transmission  
Technology (Shanghai) Co. Ltd.  
No. 435 QianPu Road  
Songjiang East Industrial Zone  
CN-201611 Shanghai, PR. China  
Tel.: +86 (0)21 37746688  
Fax: +86 (0)21 37746600  
E-mail: [info@keb.cn](mailto:info@keb.cn)  
Internet: [www.keb.cn](http://www.keb.cn)

### GERMANY

KEB Antriebstechnik GmbH  
Wildbacher Straße 5  
D-08289 Schneeberg  
Tel.: +49 (0)3772 67-0  
Fax: +49 (0)3772 67-281  
E-mail: [info@keb-combidrive.de](mailto:info@keb-combidrive.de)

### FRANCE

Société Française KEB  
Z.I. de la Croix St. Nicolas  
14, rue Gustave Eiffel  
F - 94510 LA QUEUE EN BRIE  
Tel.: +33 (0)149620101  
Fax: +33 (0)145767495  
E-mail: [info@keb.fr](mailto:info@keb.fr)  
Internet: [www.keb.fr](http://www.keb.fr)

### GREAT BRITAIN

KEB (UK) Ltd.  
6 Chieftain Business Park,  
Morris Close  
Park Farm, Wellingborough  
GB - Northants, NN8 6 XF  
Tel.: +44 (0)1933 402220  
Fax: +44 (0)1933 400724  
E-mail: [info@keb-uk.co.uk](mailto:info@keb-uk.co.uk)  
Internet: [www.keb-uk.co.uk](http://www.keb-uk.co.uk)

### ITALY

KEB Italia S.r.l. Unipersonale  
Via Newton, 2  
I - 20019 Settimo Milanese (Milano)  
Tel.: +39 02 33535311  
Fax: +39 02 33500790  
E-mail: [info@keb.it](mailto:info@keb.it)  
Internet: [www.keb.it](http://www.keb.it)

### JAPAN

KEB - Japan Ltd.  
15 - 16, 2 - Chome  
Takanawa Minato-ku  
J - Tokyo 108 - 0074  
Tel.: +81 (0)33 445-8515  
Fax: +81 (0)33 445-8215  
E-mail: [info@keb.jp](mailto:info@keb.jp)  
Internet: [www.keb.jp](http://www.keb.jp)

### RUSSIA

KEB RUS Ltd.  
Lesnaya str, house 30  
Dzerzhinsky (MO)  
RUS - 140091 Moscow region  
Tel.: +7 (0)495 5508367  
Fax: +7 (0)495 6320217  
E-Mail: [info@keb.ru](mailto:info@keb.ru)  
Internet: [www.keb.ru](http://www.keb.ru)

### USA

KEB America, Inc  
5100 Valley Industrial Blvd. South  
USA - Shakopee, MN 55379  
Tel.: +1 952 2241400  
Fax: +1 952 2241499  
E-mail: [info@kebameric.com](mailto:info@kebameric.com)  
Internet: [www.kebameric.com](http://www.kebameric.com)

**Representative offices in Belgium • Korea • Sweden • Spain**

**Further partners for ...**

Australia • Belgium • Bolivia • Brazil • Bulgaria • Chile • Czech Republic • Denmark • Egypt • Greece • Hungary • India • Indonesia • Iran • Israel • Kazakhstan • Malaysia • Morocco • Netherlands • New Zealand • Pakistan • Poland • Portugal • Romania • Singapore • Slovakia • South Africa • Spain • Sweden • Switzerland • Taiwan • Thailand • Tunisia • Turkey • Ukraine • Uzbekistan

... under [www.keb.de/en/contact/keb-worldwide.html](http://www.keb.de/en/contact/keb-worldwide.html)



© KEB 00.00.000-52F5 /06-2010 • Subject to technical alterations!

